

# SHIFTLINE



















Shiftline is the surface or suspended solution for versatile lighting applications. The miniature Shiftline 19 gives the illusion of a recessed black channel while being a surface mounted solution. With options for Uho or the petite versions of Spy, Shiftline 19 combines accent and decorative lighting. Shiftline M26 is available in two sizes with a wide variety of luminaire magnetic modules for the highest degree of freedom and flexibility.

**Listing**

ETL certified to US and Canadian safety standards.

**Warranty**

5-year limited warranty.

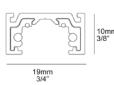
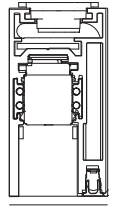
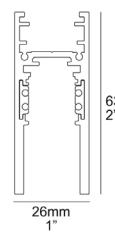
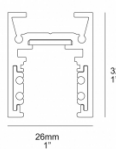
Specification	Shiftline 19	Shiftline M26H + SBL	Shiftline M26H	Shiftline M26L
LED Type:	Snap-in modules	Magnetic modules + LEDflex Small light line (see page 3)	Magnetic modules + optional LED Line Up (uplight modules)	Magnetic modules
Installation:	Surface mount	Surface / suspended		
Body/Extrusion:	Anodized aluminum			
Endcaps:	Aluminum			
Finish:	Black / White		Black / Brushed Bronze / Polished Aluminum / White	
Damp Rated (IP20) Option:	Yes			
Wet Rated (IP65) Option:	No			
Voltage:	48V			
Dimming (luminaire groups):	0-10V dim via Modulator, Wireless dim via Modulator 120-277V	N/A	0-10V dim via Modulator, Wireless dim via Modulator 120-277V	
Dimming (individual luminaires):	Dali dim 120-277V			
Power Supply:	96W Constant Voltage driver with 0.9+ power factor and 90+% efficiency			
Finish Options:	 Black  Brushed Bronze  Polished Aluminum  White	 N/A  N/A  N/A  N/A	   	   
Cross Section:	 18mm 3/4" 10mm 3/8"	 64mm 2"-1/2" 33mm 1"-5/16"	 63mm 2"-1/2" 26mm 1"	 32mm 1"-1/4" 26mm 1"

**Ordering**

SEE NEXT PAGE FOR SHIFTLINE M26H + SBL

Example: P-SLM26H-PA-R2RMTE-MDLB-B-C

Body Type	Size (W x H)	Body Finish	Installation	Application	Powerfeed	Controls	Hardware Finish <sup>6</sup>	Endcap Finish	Layout	Length				
P-SL Shiftline Profile	19 19mm x 10mm 3/4" x 3/8" Wired bus bar system	B Black	ON Surface mount	RMT Remote Power Supply Round coverplate for 4" junction box at power drops	E End feed Adds 2"-13/16 to length	D5 Dali dim	X No finished hardware	B Black	S Straight run <118" Mount end-to-end for longer runs	Nominal length in inches				
		W White							WD Wireless dim via Modulator		W White			
M26H <sup>1</sup> 26mm x 63mm 1" x 2"-1/2 Magnetic system	M26L <sup>2</sup> 26mm x 32mm 1" x 1"-1/4 Magnetic system	B Black	ON Surface mount	RMT Remote Power Supply	E End feed	D5 Dali dim	X No finished hardware	B Black	L L-Shape (2-sided)	For longer straight runs & all other shapes, continue to configuration grid on next page				
		BRB Brushed Bronze							S <sup>4</sup> Side feed		MDL 0-10V dim via Modulator	U U-Shape (3-sided)		
		PA Polished Aluminum							WD Wireless dim via Modulator		R Rectangle (4-sided)			
		W White							PB Power Box		E End feed Adds 19"-9/32 to length	ND Non-dim	B Black	C Custom
											WD <sup>5</sup> Wireless dim	W White		
									M Mid-run feed Adds 19"-9/32 to length		ND Non-dim			
	PC <sup>3</sup> Pendant, 5' cable suspended	PB Power Box	E End feed	ND Non-dim	WD <sup>5</sup> Wireless dim									
	RMT Remote Power Supply Round coverplate for 4" junction box at power drops	E End feed	D5 Dali dim	MDL 0-10V dim via Modulator										
	R2 Suspended, rigid stem 800mm / 31"-1/2 Canopy for 4" junction box at power drops	RMT Remote Power Supply Round coverplate for 4" junction box at power drops	E End feed	D5 Dali dim	WD Wireless dim via Modulator									

<sup>1</sup> M26H has option for upright when suspended; see LED Line Up specsheet for upright modules.

<sup>2</sup> M26L has options for side powerfeed and additional connectors for unique configuration options on page 4.

<sup>3</sup> Not recommended if using adjustable spot modules; opt for R2 (rigid stem).

<sup>4</sup> Only available for M26L.

<sup>5</sup> Only available for M26H.

<sup>6</sup> Applies to coverplate, rigid stem, or Power Box.  
Luminaires specified separately.

**Installation ON**

**Installation PC**

**Installation R2**

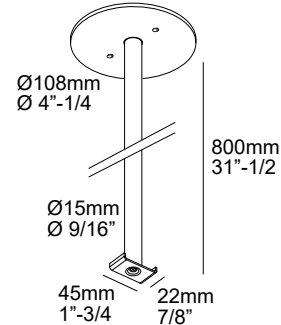
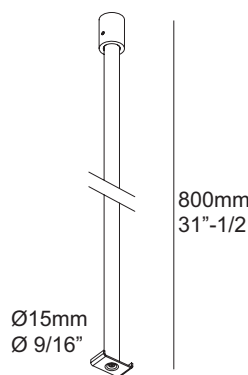
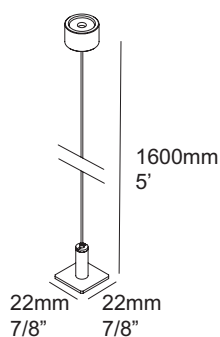
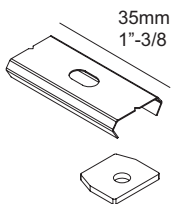

**Ordering**

ALL BOXES MUST BE FILLED IN TO CORRECTLY ORDER

Example: P-SLM26HSBL-30-B-ONRMTE-D5X-B-S3M

-  -  -  -  -  -  -  -  -  -

Body Type	Size (W x H)	LEDflex CCT	Body Finish	Installation	Application	Powerfeed	Controls	Hardware Finish <sup>2</sup>	Endcap Finish	Layout	Length
P-SL Shiftline Profile	M26HSBL 33mm x 64mm 1"-5/16 x 2"-1/2 Magnetic system with integral continuous light line	27 2700K	B Black	ON Surface mount	RMT Remote Power Supply	E End feed	D5 Dali dim	X No finished hardware	B Black	S Straight run Mount end-to-end for longer runs	2 2m / 78"-3/4
		30 3000K	W White	PC <sup>1</sup> Pendant, 5' cable suspended	PB Power Box	E End feed	ND Non-dim	B Black	W White		3 3m / 118"-1/8
		35 3500K			RMT Remote Power Supply Round coverplate for 4" junction box at power drops	E End feed	D5 Dali dim	W White			4 4m / 157"-15/32
					R2 Suspended, rigid stem 800mm / 31"-1/2 Canopy for 4" junction box at power drops	RMT Remote Power Supply Round coverplate for 4" junction box at power drops					

<sup>1</sup> Not recommended if using adjustable spot modules; opt for R2 (rigid stem).

<sup>2</sup> Applies to coverplate, rigid stem, or Power Box.  
Luminaires specified separately.

Performance	Static CCT (LEDflex Small)
CCT Options:	2700K, 3000K, 3500K
CRI:	90+
*Power:	3.4W/ft
Delivered Lumens:	252 Lm/ft
Maximum per 96W Driver:	28' 0"-27/32
Damp Rated (IP20) Option:	Yes
Wet Rated (IP65) Option:	No
McAdam Step:	3
LED Maintenance:	L70>50,000h
Voltage:	48V
Dimming:	Dali dim 120-277V
Power Supply:	96W Constant Voltage driver with 0.9+ power factor and 90+% efficiency

**Installation ON**

**Installation PC**

**Installation R2**

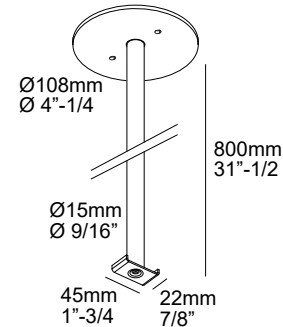
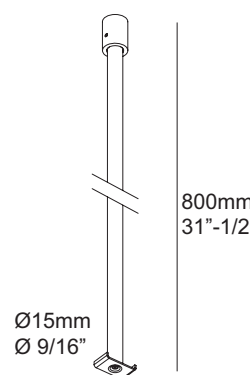
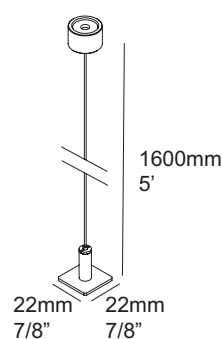
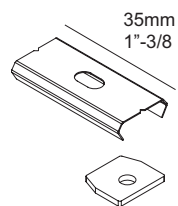

**Configuration**

DOES NOT APPLY TO SHIFTLINE M26H + SBL

Example: C-SLM26H-39-C90RM-42-C45RM-112-S180-48

Body Type	Size (W x H)	Length	Connection	Length	Connection	Length	Connection	Length
C-SL Shiftright Profile	<b>19</b> 19mm x 10mm 3/4" x 3/8" Wired bus bar system	Nominal length in inches Straight run <118"	<b>C90H</b> 90° bracket, within same plane	Nominal length in inches Straight run <118"	<b>C90H</b> 90° bracket, within same plane	Nominal length in inches Straight run <118"	<b>C90H</b> 90° bracket, within same plane	Nominal length in inches Straight run <118"
			<b>C90V</b> 90° bracket, transition between planes		<b>C90V</b> 90° bracket, transition between planes		<b>C90V</b> 90° bracket, transition between planes	
			<b>M26H</b> 26mm x 63mm 1" x 2"-1/2" Magnetic system		Nominal length in inches Straight run <118"		<b>C45RM</b> 45° radial insert, within same plane 7"-7/8 radius to outer edge	
<b>C90RM</b> 90° radial insert, within same plane 7"-7/8 radius to outer edge	<b>C90RM</b> 90° radial insert, within same plane 7"-7/8 radius to outer edge	<b>C90RM</b> 90° radial insert, within same plane 7"-7/8 radius to outer edge						
<b>C90H</b> 90° insert, within same plane Extends each inside edge 3/4"	<b>C90H</b> 90° insert, within same plane Extends each inside edge 3/4"	<b>C90H</b> 90° insert, within same plane Extends each inside edge 3/4"						
<b>M26L</b> 26mm x 32mm 1" x 1"-1/4" Magnetic system	Nominal length in inches Straight run <118"	Nominal length in inches Straight run <118"	<b>M2P</b> Stacking profile connector Transmits power between profiles, 360° rotation to set any angle	Nominal length in inches Straight run <118"	<b>M2P</b> Stacking profile connector Transmits power between profiles, 360° rotation to set any angle	Nominal length in inches Straight run <118"	<b>M2P</b> Stacking profile connector Transmits power between profiles, 360° rotation to set any angle	Nominal length in inches Straight run <118"
<b>M2X</b> Stacking profile connector No power transfer, 360° rotation to set any angle			<b>M2X</b> Stacking profile connector No power transfer, 360° rotation to set any angle		<b>M2X</b> Stacking profile connector No power transfer, 360° rotation to set any angle			
<b>M1X</b> Standoff for lower stacked profile No power transfer			<b>M1X</b> Standoff for lower stacked profile No power transfer		<b>M1X</b> Standoff for lower stacked profile No power transfer			
			<b>C90H</b> 90° insert, within same plane Extends each inside edge 3/4"		<b>C90H</b> 90° insert, within same plane Extends each inside edge 3/4"		<b>C90H</b> 90° insert, within same plane Extends each inside edge 3/4"	
			<b>S180</b> 180° joiner bracket		<b>S180</b> 180° joiner bracket		<b>S180</b> 180° joiner bracket	

If specific hardware is not noted, effect may be achievable using bevel cuts; contact factory.  
Continue for all sections / connections for each run.

SHIFTLINE 19

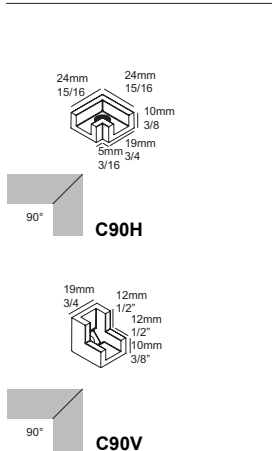

SHIFTLINE M26H

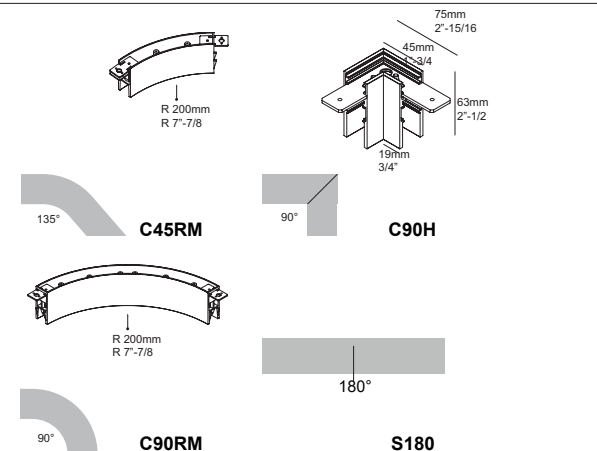

SHIFTLINE M26L

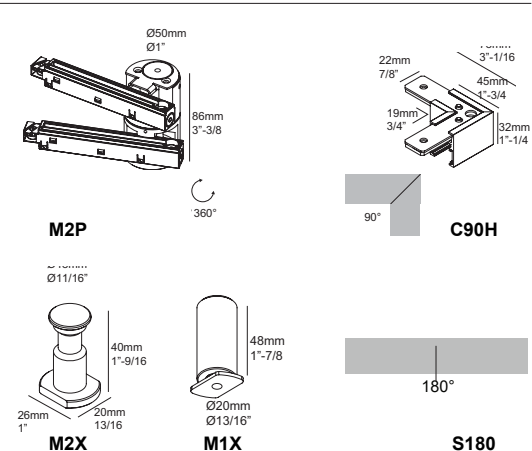

DELTA LIGHT

**Application Options**

**POWER BOX**

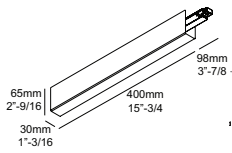

SLM26H - POWER BOX  
48V-DC / 96W (Black or White)  
For M26H Powerfeed E

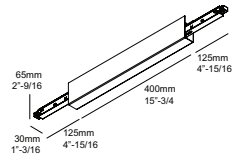

SLM26H - MID POWER BOX  
48V-DC / 96W (Black or White)  
For M26H Powerfeed M

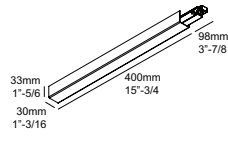

SLM26L - POWER BOX  
48V-DC / 96W (Black or White)  
For M26L Powerfeed E

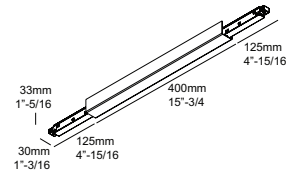

SLM26L - MID POWER BOX  
48V-DC / 96W (Black or White)  
For M26L Powerfeed M

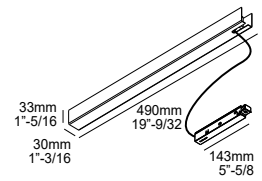

POWER BOX  
48V-DC / 96W (Black or White)  
For Installation PC

**POWERFEED**

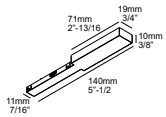

SLM19 - SUPPLY 48V  
For 19 Powerfeed E

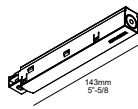

SPM - SUPPLY 48V  
For M26H/L Powerfeed E

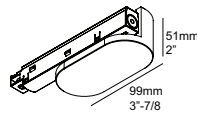

SLM26L SIDE SUPPLY 48V  
For M26L Powerfeed S

**REMOTE POWER SUPPLY**

A: 12" x B: 2"-7/8 x C: 4"-1/4  
A: 305mm x B: 72mm x C: 108mm

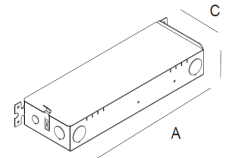

**MODULATOR**

- For Remote application
- ETL Listed
- Damp rated

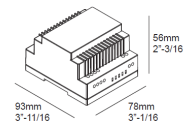

**Driver Options**

**D5**

- Dimming Control DALI
- Dimming Range 1-100%
- Dim to off yes
- Power Factor @ Full Load >0.9
- Efficiency @ Full Load ≥85
- THD @ Full Load <20%

**MDL**

- Dimming Control 0-10V / DALI
- Dimming Range 1-100%
- Dim to off yes
- Power Factor @ Full Load >0.95
- Efficiency @ Full Load ≥90
- THD @ Full Load <10%

**Dimmer Compatibility**

- Leviton IP710-DLZ
- Lutron DDTV-XX

**ND**

- Dimming Control NON DIMMABLE
- Power Factor @ Full Load >0.9
- Efficiency @ Full Load ≥90
- THD @ Full Load <10%

**WD**

- Dimming Control WIRELESS
- Dimming Range 1-100%
- Dim to off yes
- Power Factor @ Full Load >0.95
- Efficiency @ Full Load ≥90
- THD @ Full Load <10%

As technology changes, please use information above as guidance. For most recent updated information please contact factory. Specifications subject to change without notice.

## Compatible Luminaire Modules

### SHIFTLINE 19

Adjustable Spot Modules	Max per 96W Driver	Max Del Lms
Spy 20 SL	34	189
Spy 27 SL	13	498
Spy 39 SL	9	920

### SHIFTLINE M26

Adjustable Spot Modules	Max per 96W Driver	Max Del Lms	Fixed Downlight Modules	Max per 96W Driver	Max Del Lms	Linear Modules	Max per 96W Driver	Max Del Lms
*M-Boxy (Static CCT/Soft Dim/TW)	8 / 7 / 8	870	M-Dot.Com M4	14	492	**M-Dot.Com 02 WW	8	591
M-Haloscan MP (Static CCT/Soft Dim)	9 / 13	963	M-Jum-Oh! (2/4)	18 / 9	1002	**M-Dot.Com 06 WW	6	869
M-Haloscan HP (Static CCT/Soft Dim)	6 / 6	1294	M-Needle Fixed	9	496	**M-Dot.Com 08 WW	4	1298
M-Hedra (SS/MP)	13 / 7	584				**M-Dot.Com 12 WW	3	1738
M-Needle Adjustable (OK)	9	380				M-Inform L08	6	1613
M-Obin	6	1362				M-Inform L11	4	2287
M-Octav 27	13	299	<b>Decorative Modules</b>	<b>Max per 96W Driver</b>	<b>Max Del Lms</b>	M-LEDline 06 (Static CCT/Soft Dim/TW)	6 / 8 / 10	625
M-Octav 39	9	764	M-Cuppa C (Static CCT/Soft Dim)	9 / 7	863	M-LEDline 08 (Static CCT/Soft Dim/TW)	4 / 6 / 8	934
M-Odron (1/2)	8 / 4	884	M-Gibbo C	11	800	M-LEDline 10 (Static CCT/Soft Dim/TW)	3 / 5 / 6	1084
M-Spy 27 (1/2)	12 / 6	498	M-Microspy C	12	549	M-LEDline 12 (Static CCT/Soft Dim/TW)	3 / 4 / 5	1250
M-Spy 39 (1/2)	8 / 4	920	M-Multinova (Static CCT/Soft Dim)	6 / 6	1580	M-LEDline A8	4	934
M-Spy 39 Soft Dim (1/2)	13 / 6	508	M-Tweeter BL	7	1105	***LEDline Up	7	727
M-Spy 39 WW (Static CCT/Soft Dim)	8 / 13	413						
M-Spy 52 (Static CCT/Soft Dim/TW)	6 / 9 / 8	972						
M-Spy 52 WW (Static CCT/Soft Dim)	9 / 7	532						
M-Spy 66 (Static CCT/TW)	3 / 8	2079						
M-Spy 66 WW	4	1191						
M-Spy Focus (SP/XP)	8 / 4	762						
M-Vizir (SS/MP)	13 / 7	584						

\* Only available for M26L.

\*\* Only available for M26H / M26H + SBL.

\*\*\* Only available for M26H; powered via separate 24V remote power supplies.